

Stainless Steel **HINGES**

Stainless Steel **DOOR FITTINGS**

Stainless Steel **KNOBS**

Stainless Steel **SPIDER FITTINGS**

Stainless Steel **CABINET HANDLES**

Stainless Steel **GLASS PATCH FITTINGS**

Stainless Steel **MORTICE HANDLE**

Stainless Steel **SHOWER FITTINGS**

Stainless Steel **PULL HANDLES**

Stainless Steel **SCREWS**

SECTION INDEX



Stainless Steel Hinges / J-4 & 304 Grade	
Finish	Satin
Size	3" x 3/4" x 1.5 mm
	3" x 3/4" x 2.0 mm
	4" x 3/4" x 1.5 mm



Stainless Steel Hinges / J-4 & 304 Grade	
Finish	Satin
Size	3" x 1/2" x 3/4" x 1.5 mm
	3" x 1/2" x 3/4" x 2.0 mm
	3" x 1/2" x 1" x 1.5 mm
	3" x 3/4" x 1" x 1.5 mm
	4" x 1/2" x 3/4" x 1.5 mm



Stainless Steel Hinges / J-4 & 304 Grade	
Finish	Satin
Size	3" x 7/8" x 2.5 mm



Stainless Steel Hinges / J-4 & 304 Grade	
Finish	Satin
Size	4" x 1" x 2.0 mm
	4" x 1" x 2.5 mm



Stainless Steel Hinges / J-4 & 304 Grade	
Finish	Satin
Size	5" x 1.1/8" x 2.0 mm
	5" x 1.1/8" x 2.5 mm



Stainless Steel Hinges / J-4 & 304 Grade	
Finish	Satin
Size	4" x 1.1/4" x 2.5 mm
	4" x 1.1/4" x 3.0 mm
	5" x 1.1/4" x 2.5 mm
	5" x 1.1/4" x 3.0 mm

Stainless
Steel
HINGES



Button

> Stainless Steel Bearing Hinges / J-4 Grade

Finish	Satin (2 Ball Bearing)
Size	3" x 2.5" x 2.5 mm
	4" x 3" x 2.5 mm
	4" x 3" x 3.0 mm
	4" x 3.5" x 3.0 mm
	5" x 3" x 2.5 mm
	5" x 3" x 3.0 mm
	5" x 3.5" x 3.0 mm
	5" x 4" x 3.0 mm



Riveted

> Stainless Steel Bearing Hinges / 304 Grade

Finish	Satin (2 Ball Bearing)
Size	3" x 2.5" x 2.5 mm
	4" x 3" x 2.5 mm
	4" x 3" x 3.0 mm
	4" x 3.5" x 3.0 mm
	5" x 3" x 2.5 mm
	5" x 3" x 3.0 mm
	5" x 3.5" x 3.0 mm
	5" x 4" x 3.0 mm



> Stainless Steel L Type Hinges / J-4

Finish	Satin
Size	75 x 10 x 6 mm x 1.5mm
	75 x 10 x 12 mm x 1.5mm
	75 x 10 x 18 mm x 1.5mm
	75 x 10 x 25 mm x 1.5mm
	75 x 12 x 6 mm x 1.5mm
	75 x 12 x 12 mm x 1.5mm
	75 x 12 x 18 mm x 1.5mm
	75 x 12 x 25 mm x 1.5mm
	75 x 18 x 6 mm x 1.5mm
	75 x 18 x 12 mm x 1.5mm
	75 x 18 x 18 mm x 1.5mm
	75 x 18 x 25 mm x 1.5mm

SINGLE PIN RIVETING

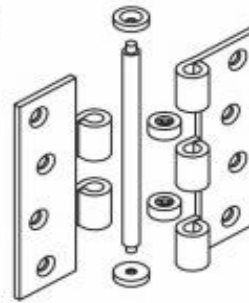

> Stainless Steel Hing Bolt

Finish	Satin
Size	Fix

Stainless Steel HINGES





> ICK - 101
Finish Satin
Diameter 19 mm



> ICK - 102
Finish Combination
Diameter 25 mm



> ICK - 103
Finish Satin
Diameter 19 mm



> ICK - 104
Finish Combination
Diameter 25 mm



> ICK - 105
Finish Satin
Diameter 25 mm



> ICK - 106
Finish Satin
Length 19 mm



> ICK - 107
Finish Satin
Diameter 25 mm



> ICK - 108
Finish Satin
Diameter 25 mm



> ICK - 109
Finish Satin
Length 25 mm

Stainless
Steel
KNOB



ICH - 101	
Finish	Combination
Diameter (mm)	8 10
Size (mm)	64 96 128 160



ICH - 102	
Finish	Combination
Diameter (mm)	8 10
Size (mm)	64 96 128



ICH - 103	
Finish	Satin, Combination
Diameter (mm)	10 12
Size (mm)	64 96 128 160 192 224 256 288 320 352 384 416 448 480 512



ICH - 104	
Finish	Combination
Diameter (mm)	10
Size (mm)	64 96 128 160 192 224 256



ICH - 105	
Finish	Combination
Diameter (mm)	10
Size (mm)	64 96 128 160 192



ICH - 106	
Finish	Combination
Diameter (mm)	10
Size (mm)	64 96 128 160 192 224 256 288 320 352 384 416 448 480 512

Stainless Steel
CABINET HANDLES

Vertical line on the left side of the page.



ICH - 107	
Finish	Combination
Diameter (mm)	10
Size (mm)	64 96 128 160 192 224 256 288 320 352 384 416 448 480 512



ICH - 108	
Finish	Combination
Diameter (mm)	10
Size (mm)	64 96 128 160 192



ICH - 109	
Finish	Combination
Diameter (mm)	10
Size (mm)	64 96 128 160 192 224 256 288 320 352 384 416 448 480 512



ICH - 110	
Finish	Combination
Diameter (mm)	10
Size (mm)	64 96 128 160 192 224 256 288 320 352 384 416 448 480 512



ICH - 111	
Finish	Combination
Diameter (mm)	10
Size (mm)	64 96 128 160 192 224 256 288 320 352 384 416 448 480 512



ICH - 112	
Finish	Combination
Diameter (mm)	14
Size (mm)	64 96 128 160 192 224 256 288

Stainless Steel
CABINET HANDLES



ICH - 113	
Finish	Combination
Diameter (mm)	14
Size (mm)	64 96 128 160 192 224 256 288 320 352 384 416 448 480 512



ICH - 114	
Finish	Combination
Diameter (mm)	14
Size (mm)	64 96 128 160 192 224 256 288 320 352 384 416 448 480 512



ICH - 115	
Finish	Glossy
Diameter (mm)	14
Size (mm)	96 128 160 192 224 256 288



ICH - 116	
Finish	Satin
Diameter (mm)	8
Size (mm)	96 128 160 192



ICH - 117	
Finish	Satin
Diameter (mm)	10
Size (mm)	64 96 128 160 192 224 256 288 320 352 384 416 448 480 512



ICH - 118	
Finish	Satin
Diameter (mm)	10
Size (mm)	64 96 128 160 192 224 256 288 320 352 384 416 448 480 512

Stainless Steel **CABINET HANDLES**



ICH - 119	
Finish	Satin
Diameter (mm)	12
Size (mm)	96 128 160 192



ICH - 120	
Finish	Satin
Diameter (mm)	12
Size (mm)	64 96 128 160 192 224 256 288 320 352 384 416 448 480 512



ICH - 121	
Finish	Satin
Diameter (mm)	12
Size (mm)	64 96 128 160 192 224 256 288 320 352 384 416 448 480 512



ICH - 122	
Finish	Satin, Combination
Diameter (mm)	25
Size (mm)	75 100 150 200 End to End



ICH - 123	
Finish	Combination
Diameter (mm)	12
Size (inch)	4 6 8 10 12 14 16 18 24



ICH - 124	
Finish	Satin, Combination
Diameter (mm)	8 10
Size (mm)	64 96 128 160 192



ICH - 125	
Finish	Satin, Combination
Diameter (mm)	8 10 12
Size (mm)	64 96 128 160 192 224 256 288

Stainless Steel CABINET HANDLES



ICH - 126	
Finish	Combination
Diameter (mm)	12
Size (mm)	96 128 160 192 224 288



ICH - 127	
Finish	Combination
Diameter (mm)	12
Size (mm)	96 128 160 192 224 256 288 352



ICH - 128	
Finish	Combination
Diameter (mm)	14
Size (mm)	96 128 160 192 224 256 288 352 384 416 448 480 512



ICH - 129	
Finish	Combination
Diameter (mm)	14
Size (mm)	64 96 128 160 192 224 256 288 352 384 416 448 480 512



ICH - 130	
Finish	Glossy
Diameter (mm)	14
Size (mm)	96 128 160 192 224 256 288 320 352



ICH - 131	
Finish	Satin
Diameter (mm)	12
Size (mm)	96 128 160 192

Stainless Steel
CABINET HANDLES

Stainless Steel **MORTICE HANDLE**

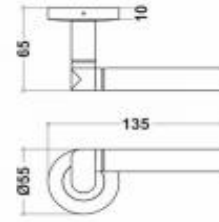

> IMH - 1 (Rose Type)	
Finish	Combination
Diameter	19 mm
> IMH - 1P (Plate Type)	
Finish	Combination
Diameter	19 mm

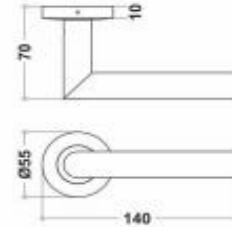

> IMH - 2 (Rose Type)	
Finish	Satin
Diameter	22 mm
> IMH - 2P (Plate Type)	
Finish	Satin
Diameter	22 mm

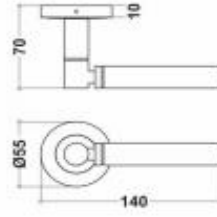

> IMH - 3 (Rose Type)	
Finish	Combination
Diameter	19 mm
> IMH - 3P (Plate Type)	
Finish	Combination
Diameter	19 mm

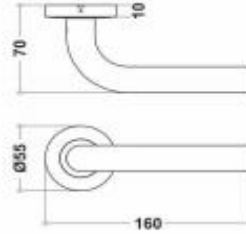

> IMH - 4 (Rose Type)	
Finish	Satin
Diameter	19 mm, 22 mm
> IMH - 4P (Plate Type)	
Finish	Satin
Diameter	19 mm, 22 mm

Stainless Steel **MORTICE HANDLE**

Stainless Steel
MORTICE HANDLE

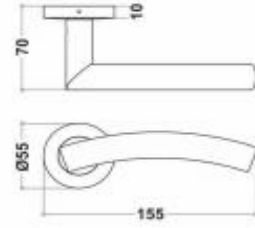

> IMH - 5 (Rose Type)

Finish	Satin, Combination
Diameter	22 mm

> IMH - 5P (Plate Type)

Finish	Satin, Combination
Diameter	22 mm

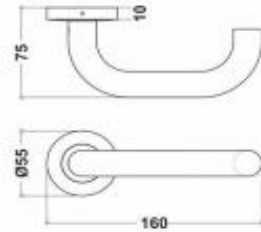

> IMH - 6 (Rose Type)

Finish	Satin
Diameter	19 mm, 22 mm

> IMH - 6P (Plate Type)

Finish	Satin
Diameter	19 mm, 22 mm

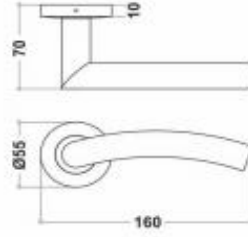

> IMH - 7 (Rose Type)

Finish	Satin
Diameter	22 mm

> IMH - 7P (Plate Type)

Finish	Satin
Diameter	22 mm

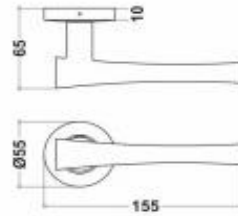

> IMH - 8 (Rose Type)

Finish	Satin, Glossy
Diameter	Solid

> IMH - 8P (Plate Type)

Finish	Satin
Diameter	Solid

Stainless Steel
MORTICE HANDLE

Stainless Steel **MORTICE HANDLE**

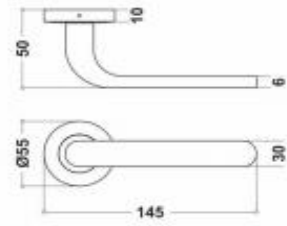

> IMH - 9 (Rose Type)	
Finish	Satin, Glossy
Diameter	Solid
> IMH - 9P (Plate Type)	
Finish	Satin
Diameter	Solid

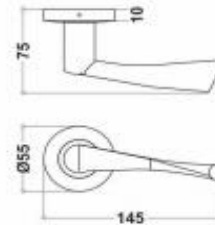

> IMH - 10 (Rose Type)	
Finish	Satin, Glossy
Diameter	Solid
> IMH - 10P (Plate Type)	
Finish	Satin
Diameter	Solid

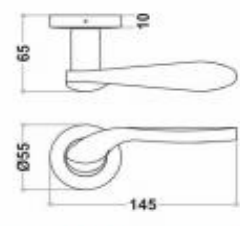

> IMH - 11 (Rose Type)	
Finish	Satin, Glossy
Diameter	Solid

> IMH - 11P (Plate Type)	
Finish	Satin
Diameter	Solid

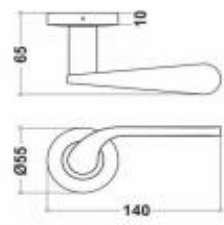

> IMH - 12 (Rose Type)	
Finish	Satin, Glossy
Diameter	Solid

> IMH - 12P (Plate Type)	
Finish	Satin
Diameter	Solid

Stainless Steel **MORTICE HANDLE**

Stainless Steel **MORTICE HANDLE**

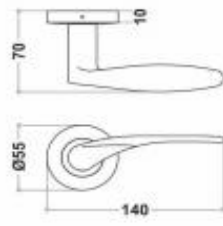

> IMH - 13 (Rose Type)	
Finish	Satin, Glossy
Diameter	Solid
> IMH - 13P (Plate Type)	
Finish	Satin
Diameter	Solid

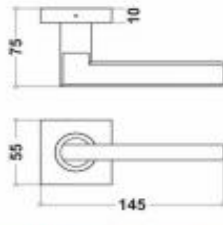

> IMH - 14 (Rose Type)	
Finish	Satin, Glossy
Diameter	Solid
> IMH - 14P (Plate Type)	
Finish	Satin
Diameter	Solid

Stainless Steel **MORTICE HANDLE**

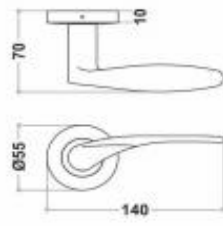

> IMH - 13 (Rose Type)	
Finish	Satin, Glossy
Diameter	Solid
> IMH - 13P (Plate Type)	
Finish	Satin
Diameter	Solid

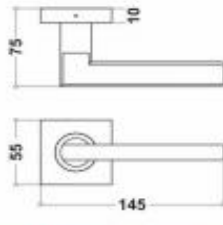

> IMH - 14 (Rose Type)	
Finish	Satin, Glossy
Diameter	Solid
> IMH - 14P (Plate Type)	
Finish	Satin
Diameter	Solid

Stainless Steel
MORTICE HANDLE

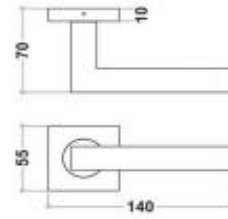

> **IMH - 17 (Rose Type)**

Finish	Satin
Diameter	19 mm

> **IMH - 17P (Plate Type)**

Finish	Satin
Diameter	19 mm

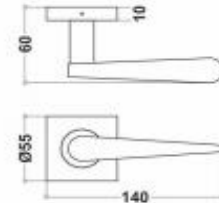

> **IMH - 18 (Rose Type)**

Finish	Satin, Glossy
Diameter	Solid

> **IMH - 18P (Plate Type)**

Finish	Satin
Diameter	Solid

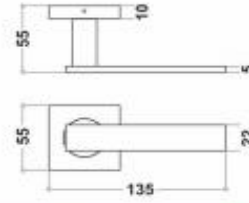

> IMH - 19 (Rose Type)	
Finish	Satin, Glossy
Diameter	Solid
> IMH - 19P (Plate Type)	
Finish	Satin
Diameter	Solid

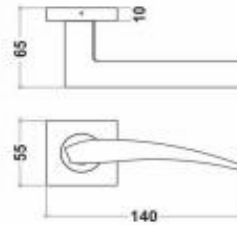

> IMH - 20 (Rose Type)	
Finish	Satin, Glossy
Diameter	Solid
> IMH - 20P (Plate Type)	
Finish	Satin
Diameter	Solid

Stainless Steel **MORTICE HANDLE**

Stainless Steel **MORTICE HANDLE**

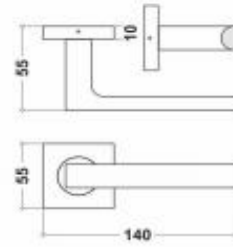

> IMH - 21 (Rose Type)

Finish	Satin, Glossy
Diameter	Solid

> IMH - 21P (Plate Type)

Finish	Satin
Diameter	Solid

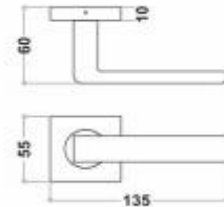

> IMH - 22 (Rose Type)

Finish	Satin, Glossy
Diameter	Solid

> IMH - 22P (Plate Type)

Finish	Satin
Diameter	Solid

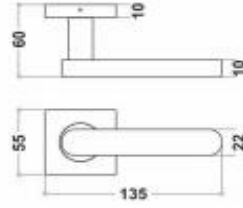

> IMH - 23 (Rose Type)

Finish	Satin, Glossy
Diameter	Solid

> IMH - 23P (Plate Type)

Finish	Satin
Diameter	Solid

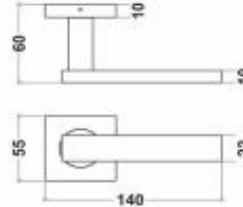

> IMH - 24 (Rose Type)

Finish	Satin, Glossy
Diameter	Solid

> IMH - 24P (Plate Type)

Finish	Satin
Diameter	Solid

Stainless Steel **MORTICE HANDLE**

Stainless Steel **MORTICE HANDLE**

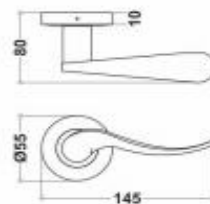

> **IMH - 25 (Rose Type)**

Finish	Satin, Glossy
Diameter	Solid

> **IMH - 25P (Plate Type)**

Finish	Satin
Diameter	Solid

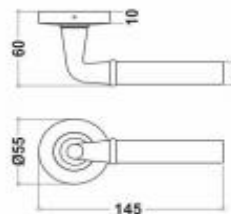

> **IMH - 26 (Rose Type)**

Finish	Satin, Glossy
Diameter	Solid

> **IMH - 26P (Plate Type)**

Finish	Satin
Diameter	Solid

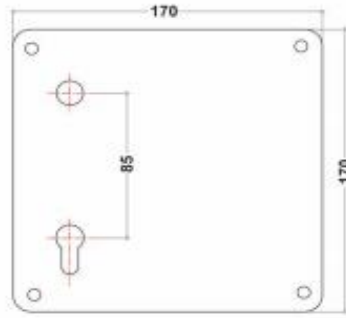

> IMH - 27	
Finish	Satin
Diameter	Fix, Mortice (170 x 170 x 1.5 mm)

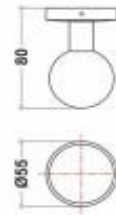

> IMH - 28	
Finish	Satin, Glossy
Diameter	50 mm

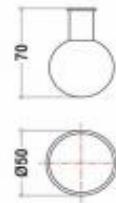

> IMH - 29	
Finish	Satin, Glossy
Diameter	50 mm (Fix)

Stainless Steel **MORTICE HANDLE**

Stainless Steel MORTICE HANDLE



> ILB - 01
 Finish Stainless Steel
 Type Single Bolt Lock Body
 Size 45mm



> ILB - 02
 Finish Stainless Steel
 Type Baby Latch
 Size Small



> ILB - 03
 Finish Stainless Steel
 Type Triple Bolt Lock Body
 Size 45mm



> ILB - 04
 Finish Stainless Steel
 Type Dead Lock Body
 Size Fix



> ILB - 05
 Finish Stainless Steel
 Type Triple Bolt Lock Body
 Size 60mm



> ILB - 06
 Finish Stainless Steel
 Type Single Bolt Lock Body
 Size Small 50mm



> IC - 01 (BSK)	
Finish	SS
Type	Both Side Key
Size	60 mm, 70 mm, 80 mm 90 mm, 100 mm



> IC - 02 (OSK) With Computerised Key	
Finish	SS
Type	One Side Key & One Side Knob
Size	60 mm, 70 mm, 80 mm 90 mm, 100 mm



> IC - 03	
Finish	SS
Type	Bathroom Cylinder
Size	60 mm, 70 mm, 80 mm



> IC - 04	
Finish	SS
Type	Half Cylinder
Size	40 mm

Stainless Steel
MORTICE HANDLE

Stainless Steel **PULL HANDLES**



IPH - 11	
Finish	Satin, Combination
Diameter (mm)	19 22 25 32
Size (mm)	150 200 250 300 450 600 900 1200



IPH - 11 T	
Finish	Satin, Combination
Diameter (mm)	22 25
Size (mm)	200 250 300 450 600 900 1200



IPH - 22	
Finish	Satin
Diameter (mm)	22
Size (mm)	200 250 300 350 400 450



IPH - 33	
Finish	Satin, Combination
Diameter (mm)	22
Size (mm)	200 250 300 350



> IPH - 33 T

Finish	Satin, Combination
Diameter (mm)	22
Size (mm)	200 250 300 350



> IPH - 44

Finish	Satin, Combination
Diameter	22 25 32
Size	150 200 250 300 350 400 450 600 750 900 1200



> IPH - 55

Finish	Satin
Diameter (mm)	15 x 30
Size (mm)	300 350 400 450 600 900 1200



> IPH - 66

Finish	Satin
Diameter (mm)	19 x 19, 25 x 25
Size (mm)	200 250 300 350 400 450 600

Stainless Steel **PULL HANDLES**

Stainless Steel **PULL HANDLES**



> IPH - 77

Finish	Satin	
Diameter (mm)	10 x 20 (Solid)	10 x 25 (Solid)
Size (mm)	200 250 300	350 400 450 600



> IPH - 88

Finish	Satin, Combination	
Diameter (mm)	22	
Size (mm)	200 250 300	



> IPH - 99

Finish	Satin	
Diameter (mm)	Oval Pipe	
Size (mm)	300 350 400 450 600	



> IPH - 111 (Adjustable Glass Door Handle)

Finish	Combination	
Diameter (mm)	25	
Size (mm)	200-300	300-450 450-600



> IPH - 222

Finish	Satin
Diameter (mm)	19 - 25
Size (mm)	200 250 300 350 400 450 600 900



> IPH - 333

Finish	Combination
Diameter (mm)	19
Size (mm)	200 250 300 350 400 450



> IPH - 444

Finish	Satin
Diameter (mm)	170 x 170 x 1.5 mm
Size (mm)	Fix



> IGR

Finish	Satin
Diameter (mm)	22
Size (mm)	150 200 250 300 350 400 450 600

Stainless Steel **PULL HANDLES**



ITB - 01	
Finish	Satin
Diameter	15 x 15 mm
Size	3" 4" 6" 8" 10" 12" 18" 24"



ITB - 02	
Finish	Satin
Diameter	9.5 mm
Size	3" 4" 6" 8" 10" 12" 18" 24"



ITB - 03	
Finish	Satin
Diameter	12.5 mm
Size	4" 6" 8" 10" 12"



ITB - 04 (Round) One Pcs. Joint Less	
Finish	Satin
Diameter	9.5 mm
Size	4" 6" 8" 10" 12"



ITB - 05 (Round) One Pcs. Joint Less	
Finish	Satin
Diameter	12.5 mm
Size	4" 6" 8" 10" 12" 18" 24"



ITB - 06 (Flush Bolt)	
Finish	Satin
Size	8" 10" 12"

Stainless Steel DOOR FITTINGS



> IDH - 101	
Finish	Combination
Diameter	16 mm
Size	8" 10"



> IDH - 105	
Finish	Combination
Diameter	16 mm
Size	6" 8" 10" 12"



> IDH - 103	
Finish	Combination
Diameter	14 mm
Size	7" 8" 9" 10"



> IDH - 123	
Finish	Combination
Diameter	19 mm
Size	6" 8" 10" 12"

Stainless Steel **DOOR FITTINGS**

Stainless Steel DOOR FITTINGS



> IGH - 01 (Round)

Finish	S. S.
Size	2" 2.1/2" 3" 4" 5" 6"

> IGH - 02 (Square)

Finish	S. S.
Size	2.1/2" 3" 4" 5" 6"

> IGH - 03 (Fancy)

Finish	S. S.
Size	4" 5" 6"



> IDS - 01

Finish	Combination
Size	Single

> IDS - 02

Finish	Combination
Size	Double

> IDS - 03

Finish	Satin
Size	Fix



> IDS - 04

Finish	Satin
Size	Big

> IDM - 01

Finish	Satin
Size	3"

> IDM - 02

Finish	Satin
Size	3"

> IDM - 03

Finish	Satin
Size	3"



> S. S. Zulla Rod (Plain-9.5mm)
 Finish Combination
 Size 1 Feet x 28 Pcs.



> S. S. Zulla Rod (Bindi-9.5mm)
 Finish Combination
 Size 1 Feet x 28 Pcs.



> S. S. Zulla Rod (Mala Goti-10mm)
 Finish Combination
 Size 1 Feet x 28 Pcs.



> Indicator Bolt
 Finish Satin
 Size Universal



> Door Chain
 Finish Satin
 Size Universal



> S. S. Zulla Bottom Ring
 Finish Combination
 Size Universal

Stainless Steel
DOOR FITTINGS

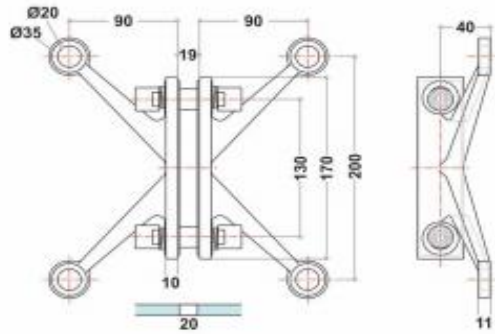

> ISF - 1 (316 Grade)
 Finish Satin, Glossy
 Type 4 Way Fin Type Spider

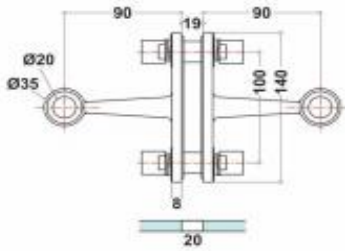

> ISF - 2 (316 Grade)
 Finish Satin, Glossy
 Type 2 Way Fin Type Spider

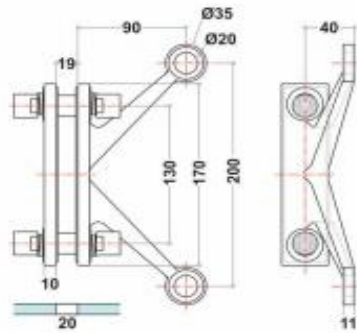

> ISF - 3 (316 Grade)
 Finish Satin, Glossy
 Type 2 Way Fin Type Spider 90°

Stainless Steel SPIDER FITTINGS

Stainless Steel SPIDER FITTINGS

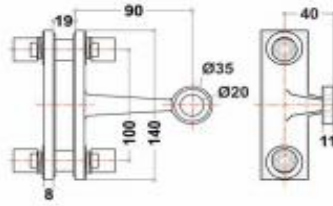

ISF - 4 (316 Grade)
 Finish Satin, Glossy
 Type 1 Way Fin Type Spider 90°

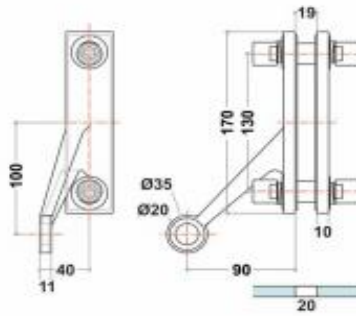

ISF - 5 (316 Grade)
 Finish Satin, Glossy
 Type 1 Way Fin Type Spider 45° Right Side

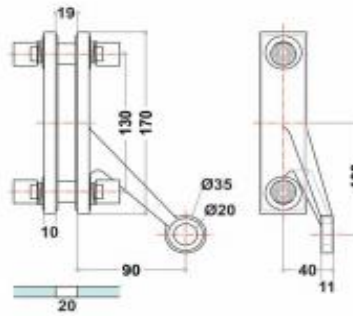

ISF - 6 (316 Grade)
 Finish Satin, Glossy
 Type 1 Way Fin Type Spider 45° Left Side

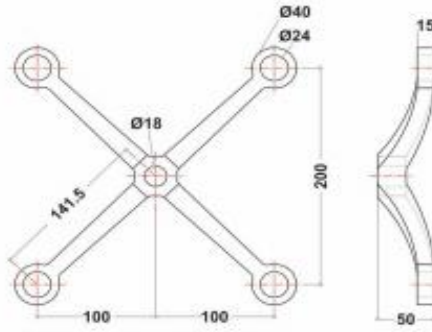

> ISF - 7 (316 Grade)
 Finish Satin, Glossy
 Type 4 Way Point Type Spider

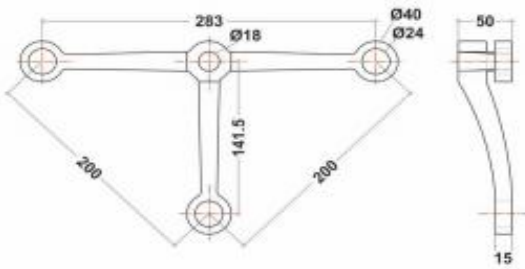

> ISF - 8 (316 Grade)
 Finish Satin, Glossy
 Type 3 Way Point Type Spider

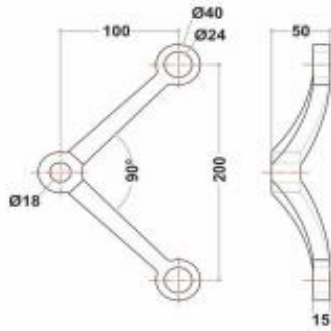

> ISF - 9 (316 Grade)
 Finish Satin, Glossy
 Type 2 Way Point Type Spider 90°

Stainless Steel SPIDER FITTINGS

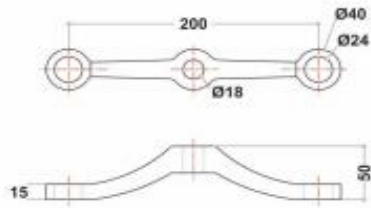

ISF - 10 (316 Grade)
 Finish Satin, Glossy
 Type 2 Way Point Type Spider 180°

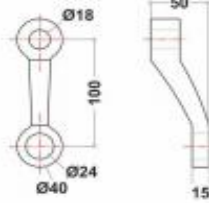

ISF - 11 (316 Grade)
 Finish Satin, Glossy
 Type 1 Way Point Type Spider





IFP - 1 (304 Grade)	
Finish	Satin, Glossy
Type	Fin Plate
Size (mm)	200 300 400

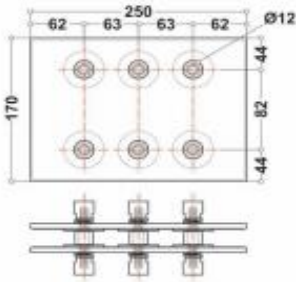
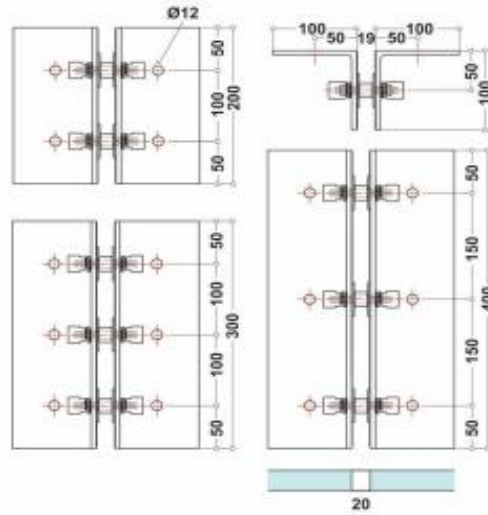

ISP - 1 (304 Grade)	
Finish	Satin, Glossy
Type	Spice Plate
Size (mm)	250 300 350

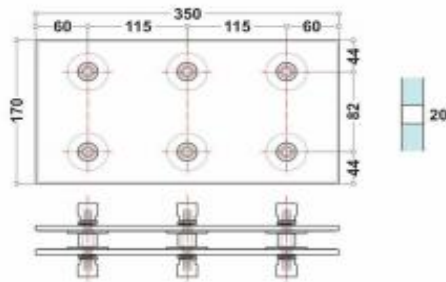
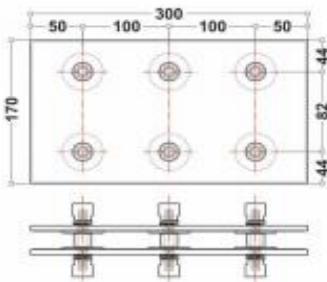

Stainless Steel
SPIDER FITTINGS

Stainless Steel SPIDER FITTINGS



ISR - 1 (304 Grade)	
Finish	Satin, Glossy
Type	Articulates Routel
Size (mm)	45 60

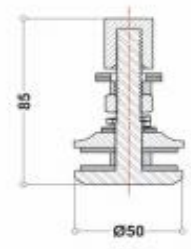
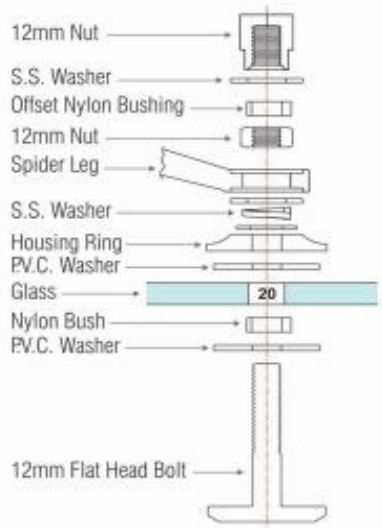
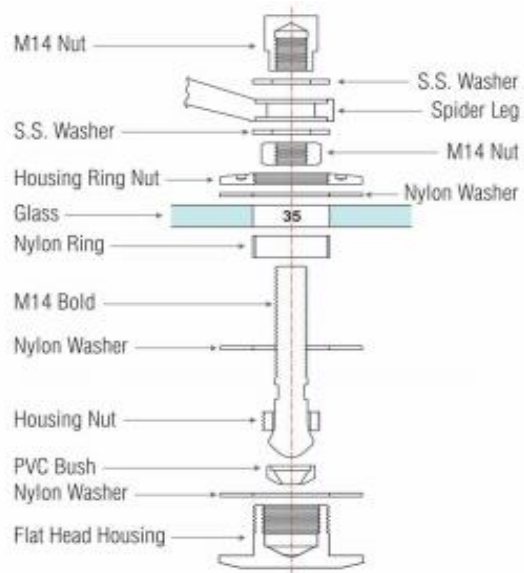

ISR - 2 (304 Grade)	
Finish	Satin, Glossy
Type	Fix Head Routel



ISR - 3 (304 Grade)	
Finish	Satin, Glossy
Type	Counter Sunk Routed

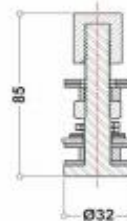
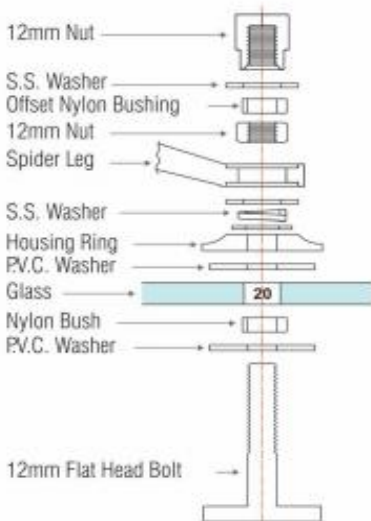
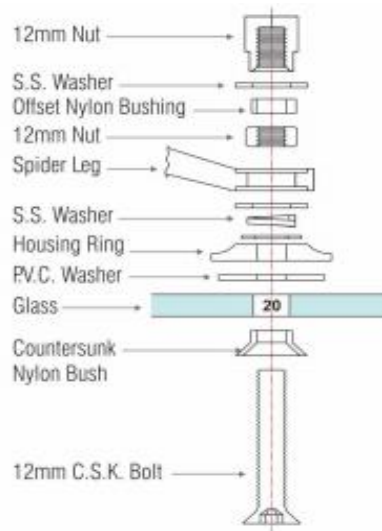

ISR - 4 (304 Grade)	
Finish	Satin, Glossy
Type	32 mm Fix Head Routed

Stainless Steel SPIDER FITTINGS

Stainless Steel
GLASS PATCH FITTINGS

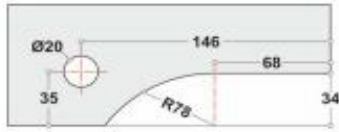

> IPF - 1

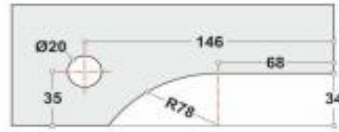

> IPF - 2

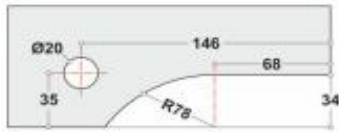

> IPF - 3

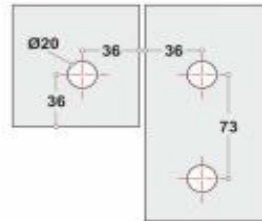

> IPF - 4

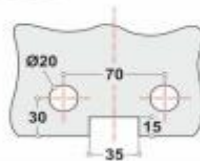

> IPF - 5

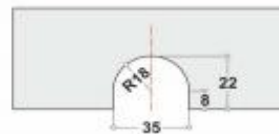

> IPF - 6

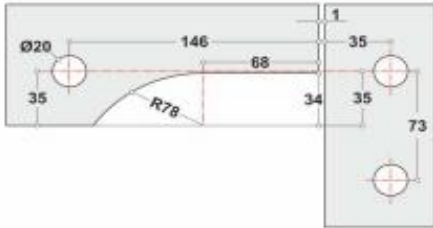

> IPF - 7

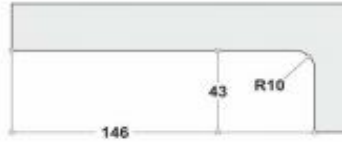

> IPF - 8

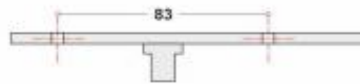

> IPF - 9
(Top Pivot Pin For Top Patch)



> IFS - 100

Floor Spring (Single Cylinder/Spring)

Technical Details

- About 100000 cycles tested
- Maximum door width 1000mm
- Maximum door weight 100kgs
- Non hold open for pool gates
- Cement box size in mm (L x W x H) 275 x 108 x 40
- Adjustment in cement box in mm (L x W x H) 12 x 8 x 8



> IFS - 150

Floor Spring (Double Cylinder/Spring)

Technical Details

- About 100000 cycles tested
- Maximum door width 1200mm
- Maximum door weight 150kgs
- Non hold open for pool gates
- Cement box size in mm (L x W x H) 306 x 108 x 40
- Adjustment in cement box in mm (L x W x H) 10 x 5 x 5

Stainless Steel GLASS PATCH FITTINGS

Stainless Steel
SHOWER FITTINGS

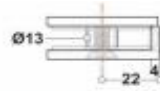

> IGC - 1 (304 Grade)	
Finish	Satin, Glossy
Type	Fix Bracket
Material	Casting

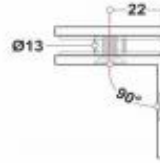

> IGC - 2 (304 Grade)	
Finish	Satin, Glossy
Type	Wall to Glass 90°
Material	Casting

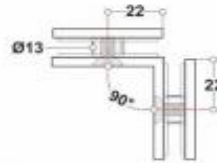

> IGC - 3 (304 Grade)	
Finish	Satin, Glossy
Type	Glass to Glass 90°
Material	Casting

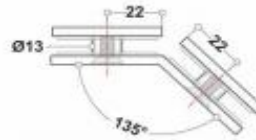

> IGC - 4 (304 Grade)	
Finish	Satin, Glossy
Type	Glass to Glass 135°
Material	Casting

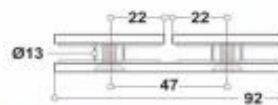

> IGC - 5 (304 Grade)	
Finish	Satin, Glossy
Type	Glass to Glass 180°
Material	Casting

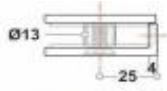

> IGC - 6 (304 Grade)	
Finish	Satin, Glossy
Type	Fix Bracket
Material	3mm - Sheet Metal



> IGC - 7 (304 Grade)	
Finish	Satin, Glossy
Type	Wall to Glass 90°
Material	3mm - Sheet Metal

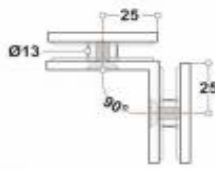

> IGC - 8 (304 Grade)	
Finish	Satin, Glossy
Type	Glass to Glass 90°
Material	3mm - Sheet Metal

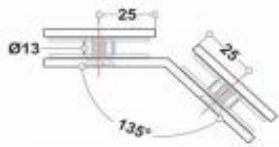

> IGC - 9 (304 Grade)	
Finish	Satin, Glossy
Type	Glass to Glass 135°
Material	3mm - Sheet Metal

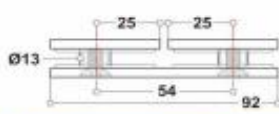

> IGC - 10 (304 Grade)	
Finish	Satin, Glossy
Type	Glass to Glass 180°
Material	3mm - Sheet Metal

Stainless Steel SHOWER FITTINGS

Stainless Steel SHOWER FITTINGS

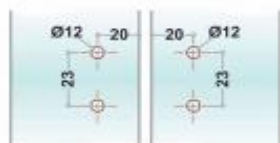

➤ IGC - 11 (304 Grade)	
Finish	Satin, Glossy
Type	Glass to Glass Hinges
Material	Casting

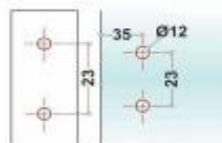

➤ IGC - 12 (304 Grade)	
Finish	Satin, Glossy
Type	Wall to Glass Hinges
Material	Casting

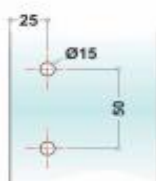

➤ IGC - 13 (304 Grade)	
Finish	Satin, Glossy
Type	Fix Bracket - Wall to Glass 90°
Material	Casting



➤ ISB - 1 (304 Grade)	
Finish	Satin, Glossy
Type	Wall to Rod Socket



➤ ISB - 2 (304 Grade)	
Finish	Satin, Glossy
Type	Rod to Glass Support Clamp



➤ ISB - 3 (304 Grade)	
Finish	Satin, Glossy
Type	Rod to Glass End Clamp



> ISB - 4 (304 Grade)

Finish	Satin, Glossy
Type	Clamp for Two way Connecting Rod



> ISB - 5 (304 Grade)

Finish	Satin, Glossy
Type	Clamp for Three way Connecting Rod



> ISB - 6 (304 Grade)

Finish	Satin, Glossy
Diameter	19 mm Pipe



> ISCH - 1 (304 Grade)

Finish	Satin, Glossy
Type	Shower Cubical Handle (Round)
Size	19 x 150 x 400 mm 19 x 150 x 450 mm 19 x 200 x 400 mm 19 x 200 x 450 mm 22 x 150 x 400 mm 22 x 150 x 450 mm 22 x 200 x 400 mm 22 x 200 x 450 mm



> ISCH - 2 (304 Grade)

Finish	Satin, Glossy
Type	Shower Cubical Handle (Square)
Size	19 x 150 x 400 mm 19 x 150 x 450 mm 19 x 200 x 400 mm 19 x 200 x 450 mm



> IGK - 1 (304 Grade)

Finish	Satin, Glossy
Type	Shower Glass Knob



> IGK - 2 (304 Grade)

Finish	Satin, Glossy
Type	Shower Glass Knob



> IGK - 3 (304 Grade)

Finish	Satin, Glossy
Type	Shower Glass Knob

Stainless Steel SHOWER FITTINGS

Stainless Steel **SHOWER FITTINGS**

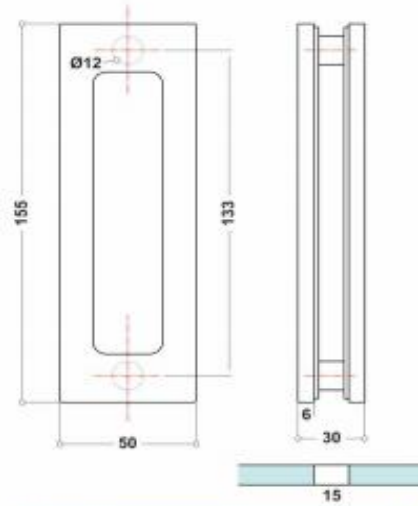

> ISDH - 1 (304 Grade)	
Finish	Satin, Glossy
Type	Sliding Glass Handle - Rectangle
Material	Casting

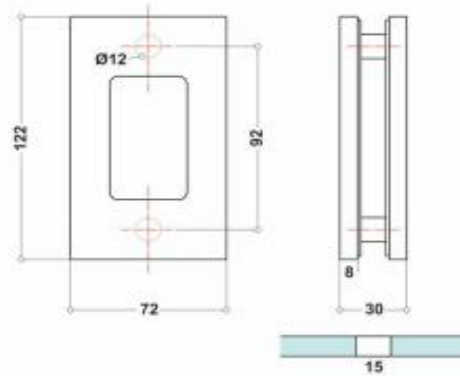

> ISDH - 2 (304 Grade)	
Finish	Satin, Glossy
Type	Sliding Glass Handle - Rectangle
Material	Casting

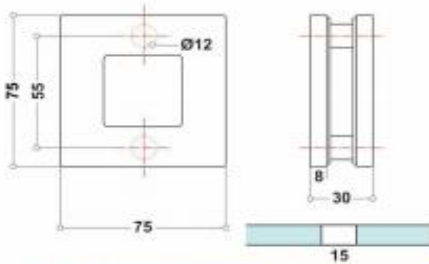

> ISDH - 3 (304 Grade)

Finish	Satin, Glossy
Type	Sliding Glass Handle - Square
Material	Casting

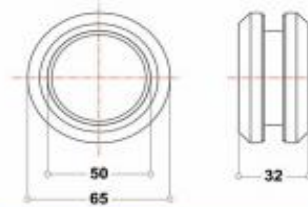

> ISDH - 4 (304 Grade)

Finish	Satin, Glossy
Type	Sliding Glass Handle - Round 50 mm
Material	Casting

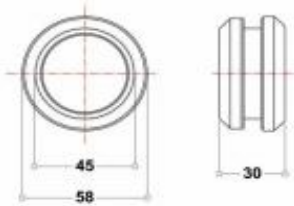

> ISDH - 5 (304 Grade)

Finish	Satin, Glossy
Type	Sliding Glass Handle - Round 45 mm
Material	Casting



> IFG - 1 (304 Grade)

Finish	Satin, Glossy
Type	Floor Guide
Material	Casting

Stainless Steel SHOWER FITTINGS



IDC - 01	
Finish	Silver
Capacity	60 Kg.
Material	Aluminium Body



IDC - 03	
Finish	Silver
Capacity	75 Kg.
Material	Aluminium Body



IDC - 02	
Finish	Silver
Capacity	65 Kg.
Material	Aluminium Body

Technical Details

- Applicable for wooden doors and the glass doors of metal frame and wooden frame.
- Maximum 500000 cycles tested without damage or maximum 1 year guarantee.
- Single ways opening with smoothly movement, hold-open optional.
- Closing speed and latching speed adjustable, BC or DA function optional.
- High quality aluminum body with silver painting.
- Different installation methods to make different closing power sizes.
- Hydraulic machine oil and sealed rings, keep perfect working in cold temperature.
- The closer is universal for right hand & left hand door.



> IDC - 04	
Finish	Silver
Capacity	75 Kg.
Material	Aluminium Body



Stainless Steel 304
Solid Plate



> Conference Table (304 Grade)	
Finish	Satin
Size	Universal

CONFERENCE TABLE



CSK Slotted Screw (204 Cu Grade)	
Material	Stainless Steel
Size	Standard



CSK Phillips Screw (304 Grade)	
Material	Stainless Steel
Size	Standard



Deep Slotted Head



Phillips Head



Sharp Thread



Pin Point

Antique Finish



Brass Finish



Stainless Steel
SCREWS